

Frameless Glass Door Patch Fittings

Top Patch

Product Code	Description	Finish
NV20SS	Top Patch for 10-12mm glass	SS
NV20PS	Top Patch for 10-12mm glass	PS
NV21SS	Top Patch with Insert for Transom Closer	SS
CP2SS	Heavy Duty	SS

Finish

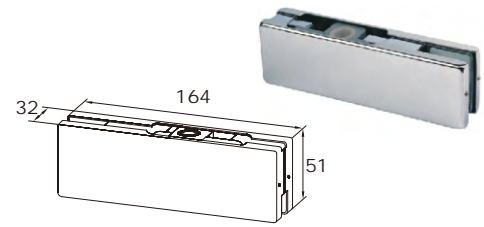

Note

- NV20/21 Zinc diecast body/Stainless covers. Max 120kg door, 1100mm width.
- CP2 Stainless body & covers. Max 140kg door, 1100mm width
- To suit Pivot.

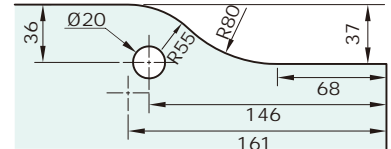

Bottom Patch

Product Code	Description	Finish
NV10SS	Bottom Patch for 10-12mm glass	SS
NV10PS	Bottom Patch for 10-12mm glass	PS
CP2SS	Heavy Duty Bottom Patch for 15mm glass	SS

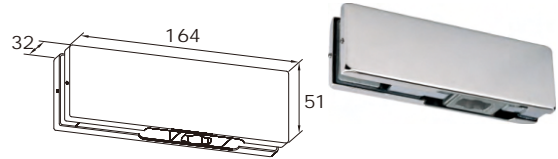

Note

- NV10 Zinc diecast body/Stainless covers. Max 120kg door, 1100mm width.
- CP1 Stainless body & covers. Max 140kg door, 1100mm width
- To suit Floor Spring or Floor Pivot.

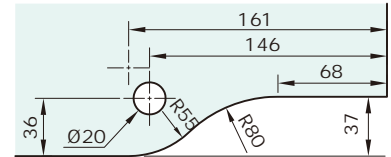

Overpanel Patch with Pivot

Product Code	Description	Finish
NV30SS	Overpanel Patch with Pivot	SS
NV30PS	Overpanel Patch with Pivot	PS
CP3SS	Heavy Duty Overpanel Patch with Pivot for 15mm glass	SS

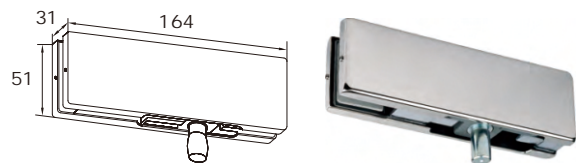

Note

- NV30 Zinc diecast body/Stainless covers. Max 120kg door, 1100mm width.
- CP3 Stainless body & covers. Max 140kg door, 1100mm width
- To suit NV20/CP2.

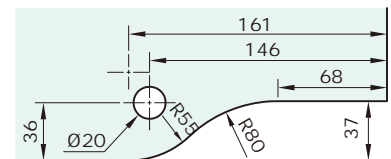

Overpanel to Side Panel

Product Code	Description	Finish
NV40SS	Overpanel to side panel with Pivot	SS
NV40PS	Overpanel to side panel with Pivot	PS
CP4SS	Heavy Duty Overpanel to Side Panel with Pivot for 15mm glass	SS

Note

- NV40 Zinc diecast body/Stainless covers. Max 120kg door, 1100mm width.
- CP4 Stainless body & covers. Max 140kg door, 1100mm width
- To suit NV20/CP2.

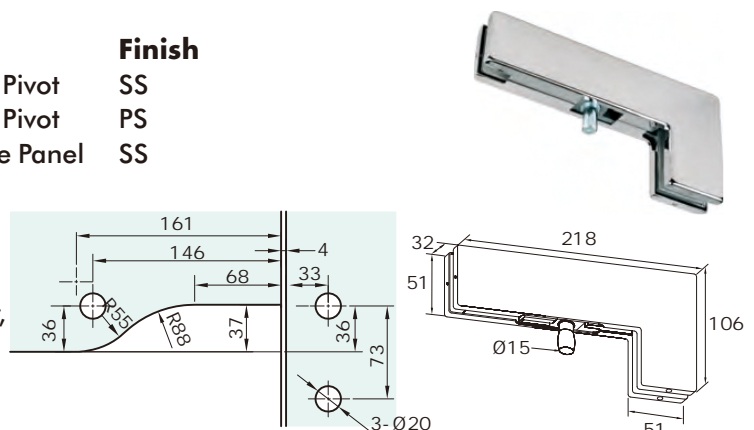

Frameless Glass Door Patch Fittings

Top/Bottom Patch Lock & Strikes

Product Code	Description
NV50SS	Bottom Patch Lock 10-12mm glass
NV50PS	Bottom Patch Lock 10-12mm glass
NV51SS	Top Patch Strike
NV51PS	Top Patch Strike
CP5SS	Heavy Duty Bottom Patch Lock for 15mm glass

Finish
SS
PS
SS
PS
SS

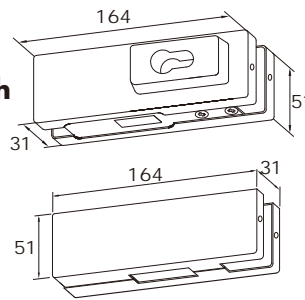

NV50 Patch lock cut-out

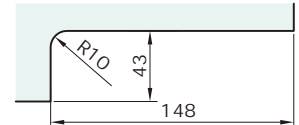

Note

- NV50/51 Zinc diecast body/Stainless covers.
Max 120kg door, 1100mm width.
- CP5 Stainless body & covers.
Max 140kg door, 1100mm width.
- Europrofile Cylinder, keyed to differ.
- 16mm throw, flat timber or floor strike provided.

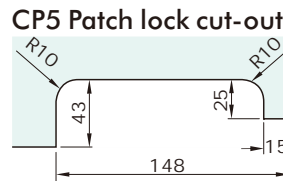

CP5 Patch lock cut-out

Strike cut-out

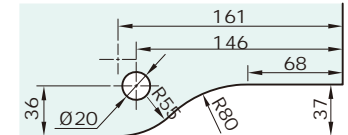

Centre Patch Lock & Strikes

Product Code	Description	Finish
NV55SS	Centre Patch Lock	SS
NV55PS	Centre Patch Lock	PS
NV57SS	Centre Patch Strike	SS
NV57PS	Centre Patch Strike	PS

Note

- Zinc diecast body/Stainless covers.
- 10-12mm glass, Max 120kg door, 1100mm width.
- Europrofile Cylinder, keyed to differ.
- 16mm throw, flat timber or floor strike provided.

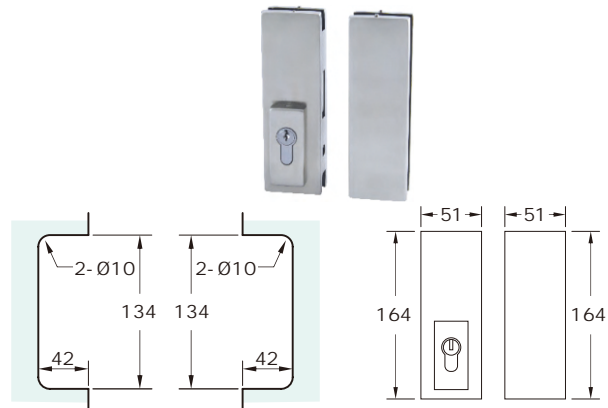

Double Glass Strikes

Product Code	Description	Finish
NV52SS	Double Glass Strike	SS
NV52PS	Double Glass Strike	PS

Note

- Zinc diecast body/Stainless covers.
- Max 120kg door, 1100mm width.
- 10-12mm glass.
- To suit NV50.

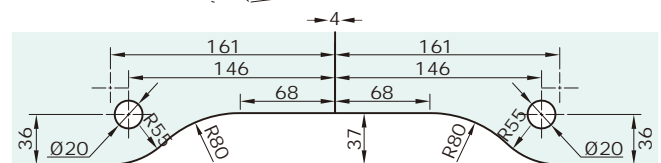
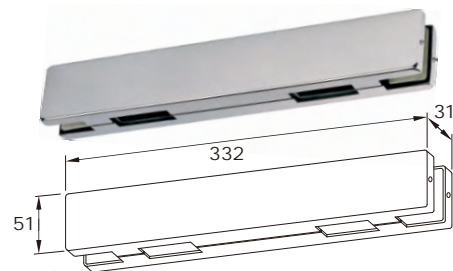

Overpanel Patch with Pivot & Wall Plate

Product Code	Description	Finish
NV72SS	Overpanel Patch with Pivot & wall plate	SS
NV72PS	Overpanel Patch with Pivot & wall plate	PS

Note

- Zinc diecast body/Stainless covers.
- 10-12mm glass.
- Max 120kg door, 1100mm width.
- To suit NV20.

