

Patch Fittings

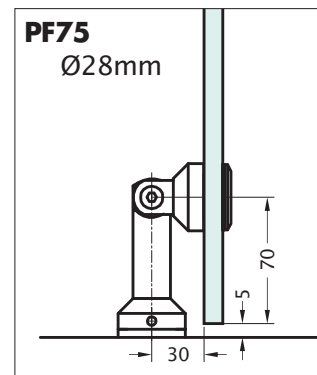

Floor Spring Position Offset/Glass Offset

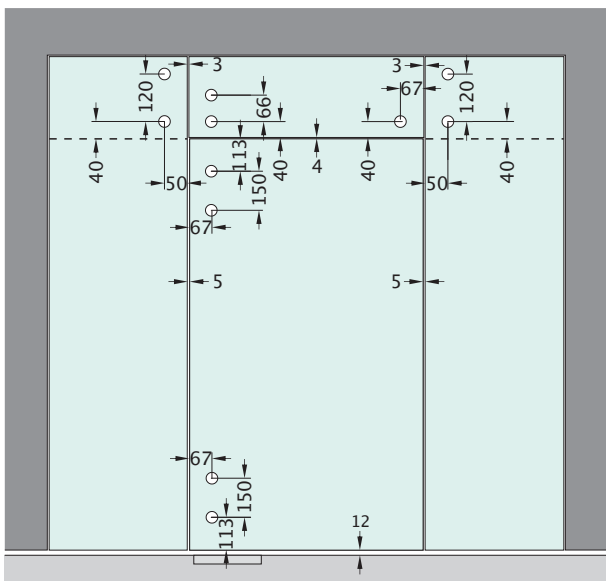
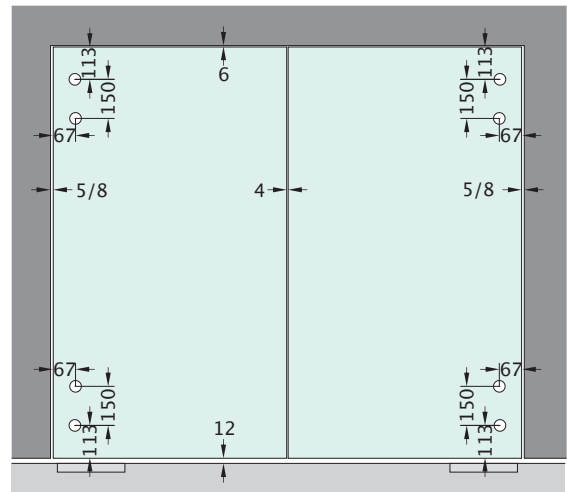
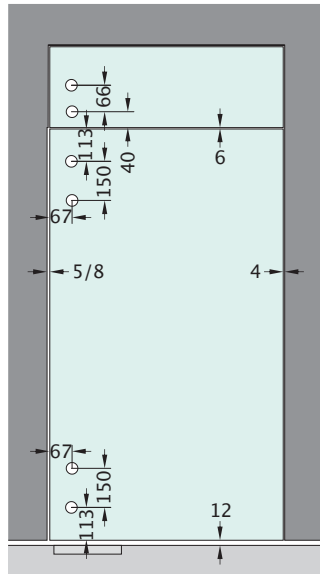
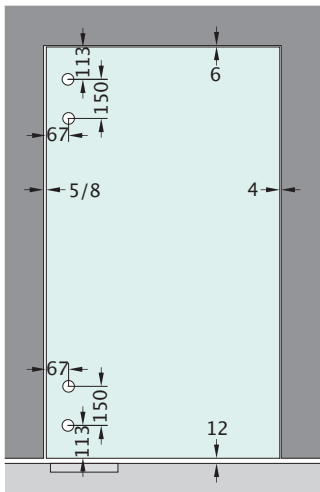
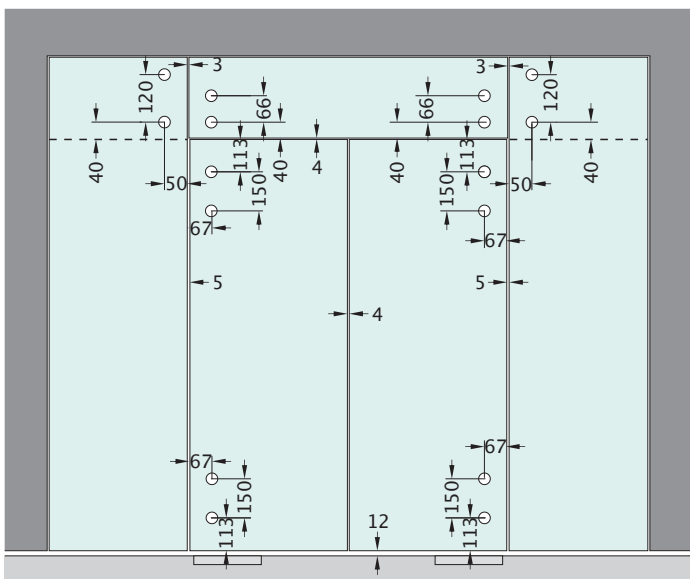
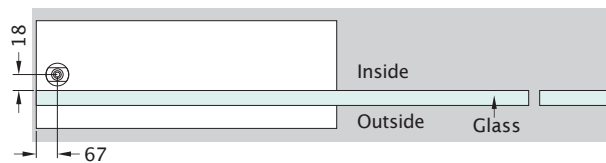

Notes

- Add handle centres as required.
- Note offset position of Floor Spring.
- Gap between walls × Door 8mm.
- Gap between glass sidelite × door 5mm.
- No deductions made in glass for glazing into channels etc.
- All holes 28mmØ.
- 10 or 12mm glass.
- If a floor pivot is used make bottom door gap 10mm.